

M21D 80 M 2c

1 ~ 220V 50 Hz

Çalışma Türü /
Duty Type : S1

Koruma Sınıfı /
Degree of protection : IP 55 (TEFC)

Yalıtım Sınıfı
Insulation class : F (155 °C)

Isı Artışı /
Temp rise : Class B (80K)

Yapı Biçimi /
Mounting Design : B34

GAMAK

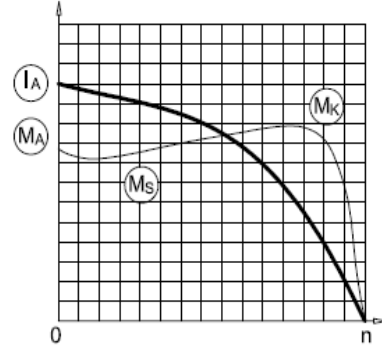

ELEKTRİKSEL TASARIM / ELECTRICAL DESIGN

Çıkış Gücü /
Rated output (kW) : 0,75

Anma Hızı /
Rated Speed (rpm) : 2890

Anma Akımı /
Rated current (A) : 5,20

Anma Momenti /
Rated Torque – Mn (Nm) : 2,48

Kalkış Kondansatör 330 V (µF) /
Start Capacitor 330 V (µF) : -

Daimi Kondansatör 400 V (µF) /
Run Capacitor 400 V (µF) : 30

Güç Faktörü Cos φ /
Power factor Cos φ : 0,96

Verim % /
Efficiency % : 68,0

Eylemsizlik Momenti J(kg.m²) /
Moment of inertia J(kg.m²) : 0,00056

Kalkış Akımı /
Locked rotor Current – Ia (A) : 19,76

Ia / In : 3,8

Kalkış Momenti /
Locked rotor Torque – Ma (Nm) : 1,5

Ma / Mn : 0,60

Devrilme Momenti /
Breakdown Torque – Mk (Nm) : 5,0

Mk / Mn : 2,0

MEKANİK TASARIM / MECHANICAL DESIGN

Gövde /
Frame : Alüminyum /
Aluminum

Kapaklar /
End shields : Alüminyum /
Aluminum

B14 Flanş /
B14 Flange : Alüminyum /
Aluminum

Soğutma Fanı /
Cooling fan : Plastik /
Plastic

Klemens Kutusu /
Terminal box : Plastik /
Plastic

Rakorlar /
Cable gland : M20

Rakor Adedi /
No of cable glands : 1

Yatak Bilgileri / Bearing Arrangement

Standart Tasarım /
Standard Design

Boya /
Paint : RAL 7031 Gri/Grey
Yaklaşık Ağırlık /
Approximate weight (kg) : 9,1

Ön Rulman / Drive End

: 6304 ZZ

Arka Rulman / Non Drive End

: 6202 ZZ

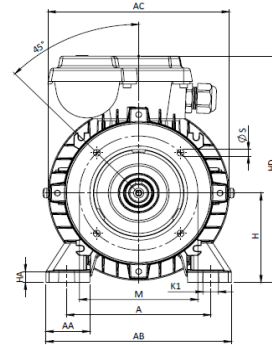
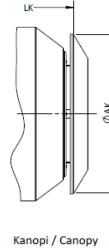
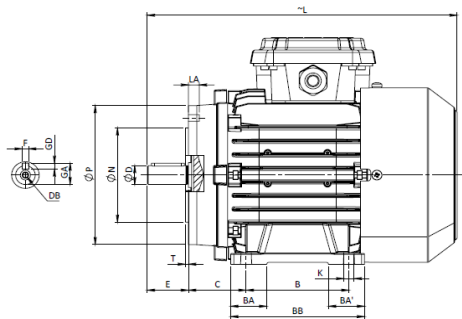

BOYUTLAR / DIMENSIONS

Ayaklı ve flanşlı motor boyutları (Flanş Biçimi C - DIN EN 50 347) B34 yapı biçiminde /
Dimensions of foot and flange mounted motors: (C-Face Flange form C - DIN EN 50 347) B34 mounting

H	HD	HA	A	AA	AB	ACØ	AKØ	KØ	K1	B	B'	BA	BA'	BB	Flanş / Flange No	MØ	NØ	PØ	SØ	T	LA	L	LK	C	E	DB	DØ	GA	FxGD
80	211	10	125	38	160	156	151	10	15	100	-	33	-	125	FT 100	100	80	120	M6	3	-	249	278	45	30	M5	14	16	5X5
80	211	10	125	38	160	156	151	10	15	100	-	33	-	125	FT 130	130	110	160	M8	4	-	249	278	45	30	M5	14	16	5X5